

TRU-LY THE BEST



Sustainable Transport Refrigeration



Available exclusively on Utility Trailer 3000R® refrigerated trailers

TRUSTED. TESTED. TRU.

Well-known around the world and road-proven in some of the hottest temperatures on Earth, Cargobull TRUs were conceived in 2007 by one of the most well-known names in trailer refrigeration—Schmitz Cargobull—with a goal of becoming the complete solution for temperature transportation.

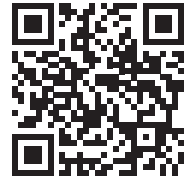

Visit utilitytrailer.com

After rigorous field testing and a decade with tens of thousands of TRUs on European roads, Cargobull North America introduced the 625 Hybrid Mono-Temp and 655MT Hybrid Multi-Temp on Utility's industry-leading 3000R refrigerated trailer, becoming the first in North America to integrate trailers, cooling units, and telematics.

Available exclusively through Utility Trailer's vast, reliable dealer network, Cargobull TRUs are taking fleets seamlessly into the future of sustainability and performance.





*Be TRU-LY powerful
with energy-efficient
temperature-controlled
transportation.*



Zero local emissions and
100% cooling performance
with shore power



10% or more fuel savings
and lower operating costs



Ultra-low emission
TRU (ULETRU), cleaner
burning with lower fuel
consumption



“Evergreen” Lifetime
regulatory compliance with
California Air Resources
Board (CARB)



Up to 50% fewer defrosting
cycles for greater energy
savings and continued
cooling output



Follow the elephant to efficient, reliable sustainability.

High quality, impact resistant shell

Fuel efficient common rail diesel engine

Fuel indicator light visible from truck cab

No belt drive generator

Quiet operation and noise suppression





***SUSTAINABLE
AND EFFICIENT IN
ANY WEATHER ...
IT'S TRU-LY BETTER
FOR BUSINESS***



*Less drag
saves you more.*



The Cargobull's slim-line profile and lower weight offer improved aerodynamics and tractor weight distribution, all without stifling the airflow around the TRU, leading to better all-around truck and trailer fuel efficiency.



655MT
HYBRID



Power ahead of the competition and stay ahead of CARB regulations.

The hybrid powertrain directly couples the diesel engine and generator, giving you a high-reliability industrial engine that's environmentally friendly with the lowest possible fuel consumption. The Cargobull TRU is a monumental leap forward in energy efficiency and sustainability. Without using a problematic diesel-particulate filter (DPF) or exhaust gas recirculation valve (EGR), it provides CARB lifetime (Evergreen) compliance. Future-proofing with industry-standard shore power provides the stepping-stone to full electric operation.



CARGOBULL
NORTH AMERICA

*Keep watch, communicate,
and drive industry forward.*

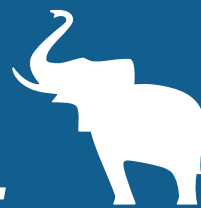

The industry-first standard, fully integrated high output (65W) solar panel combined with an AGM battery ensures continuous telematics communication. The panel is at an incline to prevent water pooling and build up of snow and ice. It is strategically located below the roof line to protect it from impact damage.

Maintain optimal temperature and zero emissions.

A fully embedded, industry-standard 480V power receptacle is located at the back of the 3000R. This technology completely eliminates local diesel emissions to protect the environment but also saves you money by reducing fuel usage and wear and tear.

Get intelligent shore power with UTILITY TrailerConnect. When shore power is flowing to the Cargobull TRU, the trailer parking brakes are engaged and cannot be released until shore power is no longer flowing, preventing the trailer from pulling away from the dock.

NOW THAT'S SMART

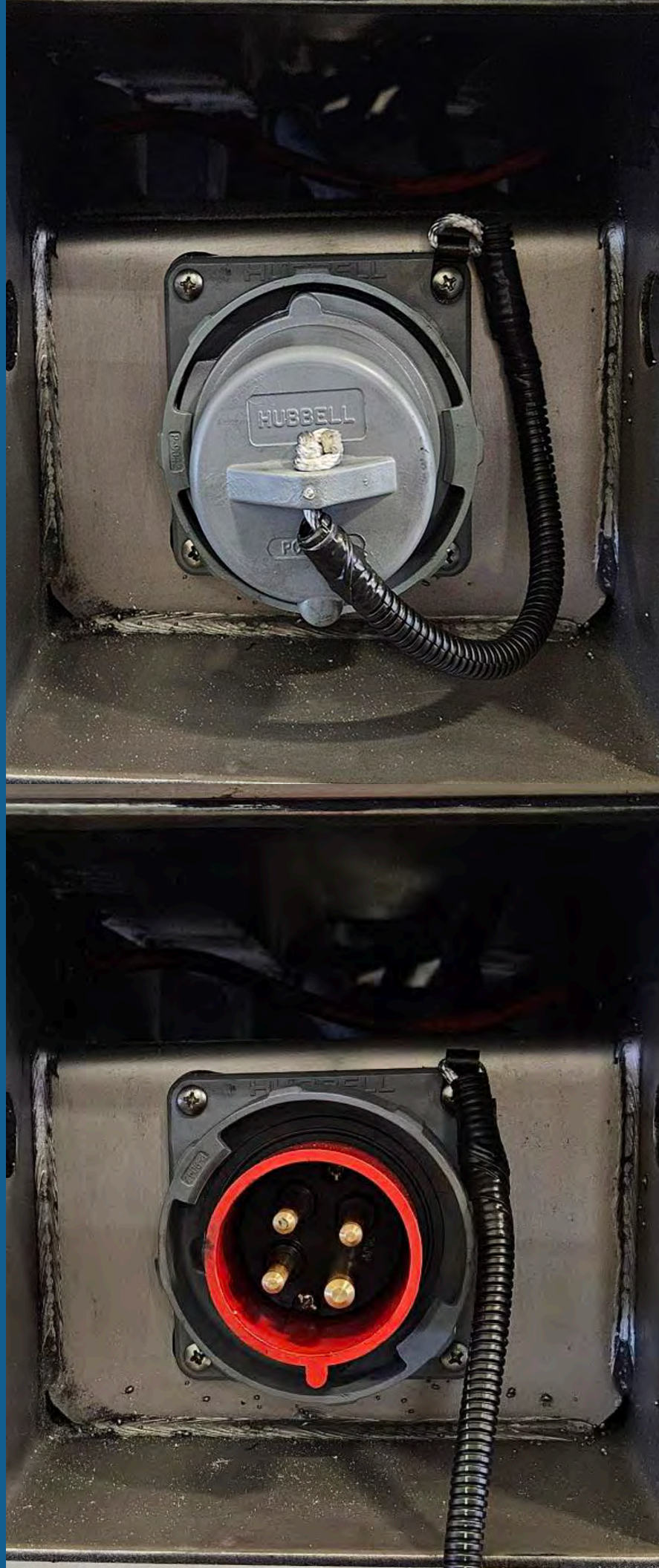



***PERFORMANCE
AND RELIABILITY
TO KEEP YOU
MOVING FORWARD***





All the fanfare without the noise.



From unit doors with standard noise suppression, tuned intake eliminating diesel drone, and the Hatz high torque 2ltr engine running at a quiet and more fuel efficient 1800RPM, Cargobulls are powerful and less noisy.

Convenient access and durability—a great return awaits.

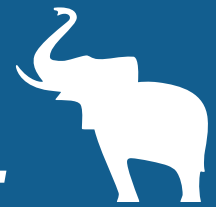

The removable air return bulkhead engineered by FG Products provides convenient access to the refrigeration unit, making cleaning the bulkhead, evaporator coil, and defrost lines easier. The bulkhead's slim profile saves room to maximize load space, and five heavy-duty aluminum pallet stops prevent impact damage.





Easy access equals savings on maintenance and repair.



A modular construction and all filters located on the front face of the engine reduces repair times and simplifies maintenance. The TRU's bolted construction with a galvanized and coated steel structure dramatically reduces "frame rot," or corrosion.

Blanketing your load with uniformly cool air.



The unique air distribution system integrated into the 3000R sets new standards in eliminating hot spots and providing a uniform cool air blanket throughout the trailer. Powered by three variable speed fans that are ducted through flexible impact-resistant rubber snorkels, air distribution is optimized. Standard on the 625 and optional on the 655MT, unequal-length air chutes further optimize air distribution in large compartments.





***Load more confidently in the
3000R[®] with a Cargobull TRU.***



The low-profile design of the remote ceiling-mounted evaporator allows greater product height, increased load capacity, and less chance of fork truck impact. The durable housing with an integrated stainless steel guard frame helps to protect from damage. Two high-velocity fan motors and an elongated, less restrictive coil provide high discharge air speed and increased volume for large rear compartments.

*available on 655MT

Unwanted surprises with your reefer loads are a thing of the past.

The UTILITY TrailerConnect UTC-TABS8PRO telematics is the central nervous system of the Cargobull-equipped 3000R refrigerated trailers. Integrated into all TRUs, the UTILITY TrailerConnect provides proactive notifications about the reefer and running gear, such as shutdown alerts and ABS error codes.

With the UTILITY TrailerConnect portal and app, telematics data can be streamlined directly to industry-standard frontends, fleet operators, and transport management or enterprise resource planning systems.



Download the Telematics Brochure

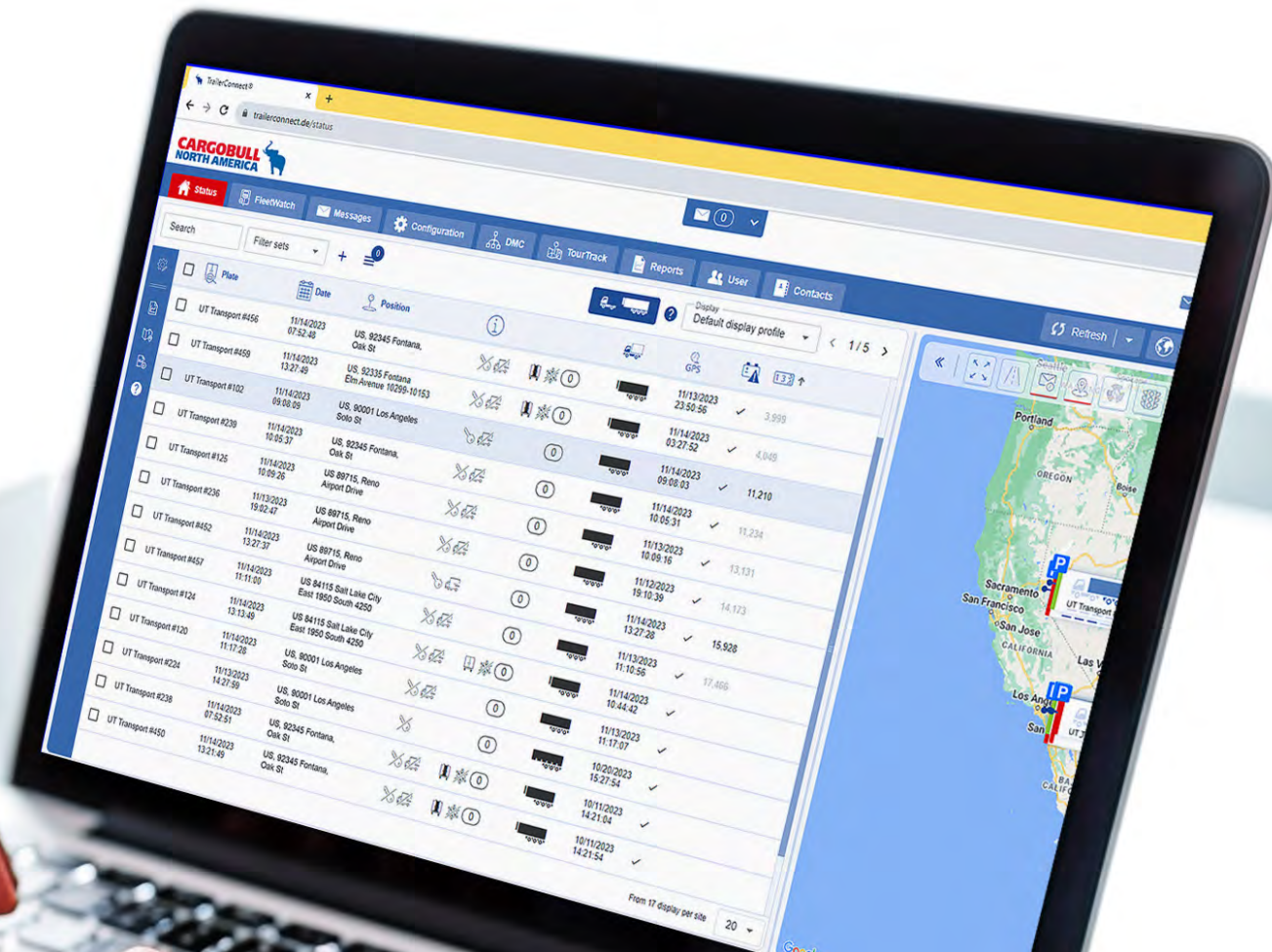



Coming soon! We're raising the bar in all-electric TRUs.

The e625 and e655MT are emission-free, all-electric TRUs with innovative charging technology. Providing efficient, safe, and sustainable transport of temperature-controlled cargo with 100% electrically powered units on industry-standard 480v power, these TRUs have 15,800 watts cooling capacity and 10,500 watts heating capacity at 32°F, which offers high cooling capacity and short defrosting cycles, while simultaneously charging the power pack.

The 32kWh LiFePO₄ power pack provides 4 to 8 hrs of normal operation, and a recuperative axle (coming soon) ensures continuous operation of the unit. Along with integrated telematics and intelligent energy management control, this TRU provides efficient operation with preset modes and optimized temperature control specifically designed for transporting sensitive goods.

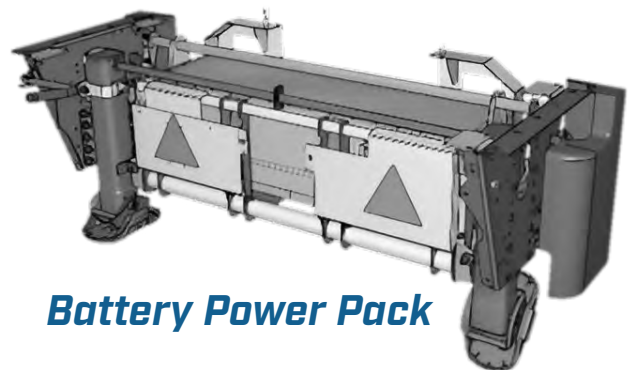

Battery Power Pack

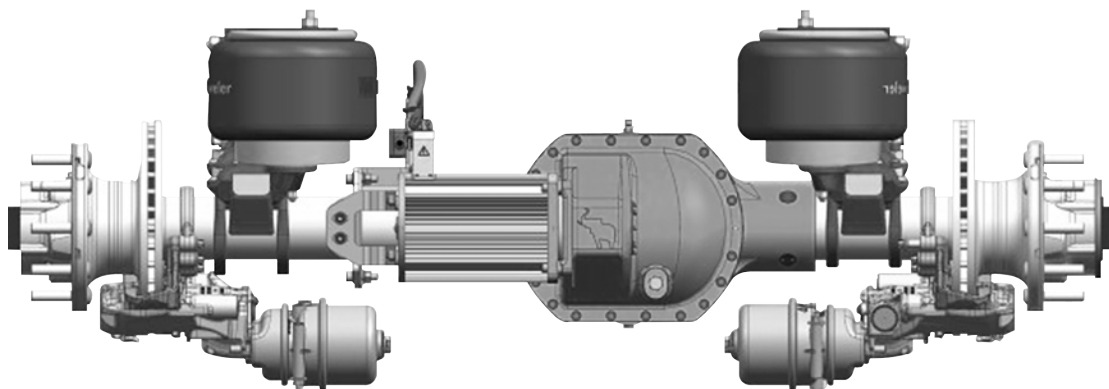

Recuperative Axle



***Peace of mind comes standard
with Utility's warranty and
service packages.***



All Utility Trailer 3000Rs sold with the optional Cargobull TRU come with a 5-year limited warranty in a variety of full-service maintenance packages of up to 5 years and 12,500 hours. They also come with five years of trailer and TRU telematics via UTILITY TrailerConnect. Other service packages, with additional annual engine hours, are also available.

Access a vast network of customer-focused dealers for all your trailer needs.



Whether you need sales, parts, or service, you can count on our dealers across North America. We're growing all the time, so visit utilitytrailer.com for the most current listing of Utility dealers. Additionally, Aurora Parts dealers have quick access to the full line of Cargobull service parts from their six strategically located Parts Distribution Centers.



Utility Trailer Dealers - Sales, Parts, & Service



Aurora Parts Dealers

CARGOBULL
NORTH AMERICA



Visit utilitytrailer.com

**Specifications, data, availability and images are subject to change without notice.*

© 2024 Cargobull North America, LLC